

RONJA

A night photograph of a cityscape. A large, bright red laser beam is projected from the top center of the frame, creating a large, glowing red circular area in the sky. In the center of this red area is a bright yellow light source, possibly a laser or a light fixture. The background shows a multi-story apartment building with many lit windows, and other buildings and streetlights are visible in the distance.

Optical datalink

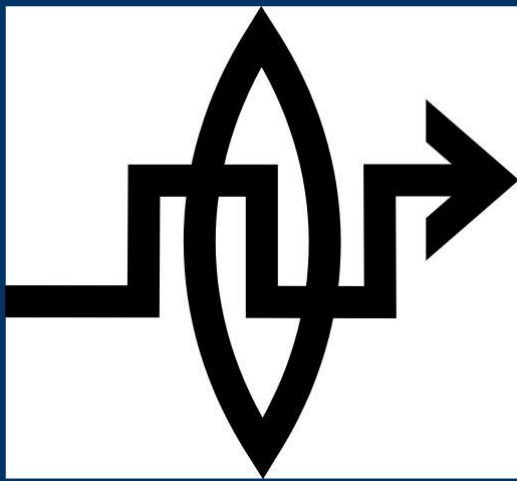

RONJA PROJECT



- 1998: Experiments with IR 115.2kBaud
- 2004:
 - 10Mbps
 - Full duplex
 - 1.4km range
- User Controlled Technology (UCT)

Prehistory: Heliograph

- 405 B.C. Ancient Greeks
- 1910
- -1960



Aldis Lamp

- Late 19th century – 1997
- Naval radio silence, early ATC

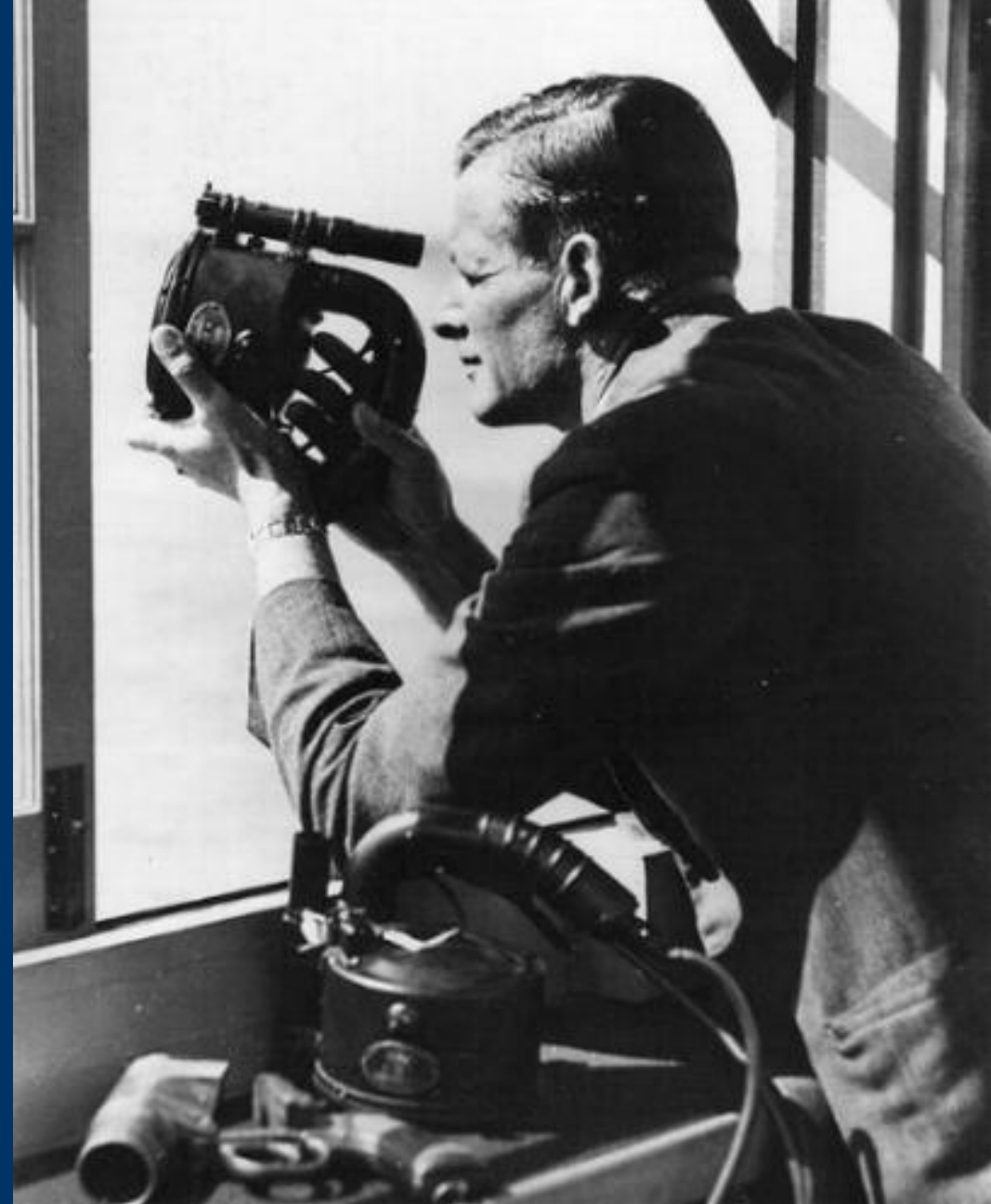

Simple encoding

- $\frac{1}{2}$ sec. Light, $\frac{1}{2}$ sec. Dark \rightarrow logical 0
- $\frac{1}{2}$ sec. Dark, $\frac{1}{2}$ sec. Light \rightarrow logical 1
- Speed up 10,000x : 10Base ethernet

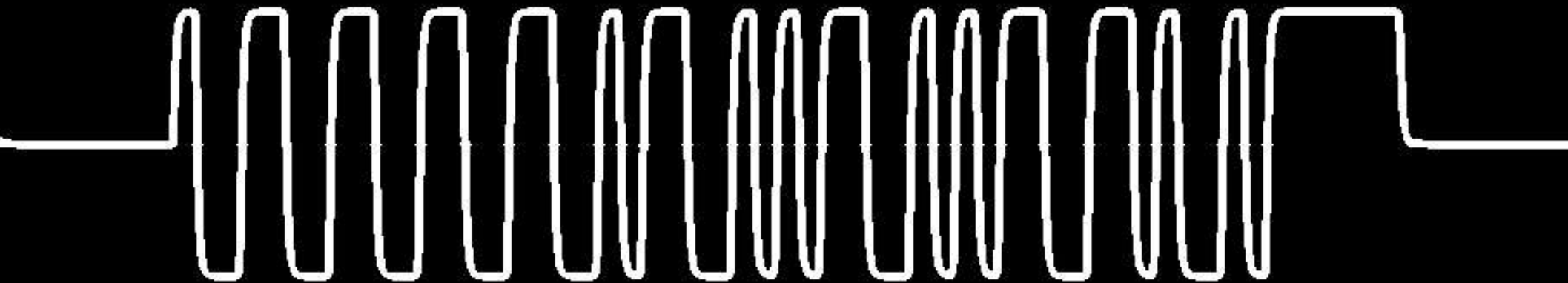

Transmitter

- LED + 13cm lens, 17mW of light
- Unconditionally eye safe
- 10MBaud, 100% depth
- 14' divergence
- 4m spot @ 1km



Advantages

- No interference
- No spectrum regulation
- No electrosmog
- Difficult eavesdropping
- Smooth throughput
- Full duplex
- BER 10^{-9}



Disadvantages



- Dropouts on fog
 - Mount requirements
 - PtP topology only
 - Range limited by extinction
 - Mechanics: 10-20kg
-
-

Range

- Rain OK
- Visibility = 17dB attenuation of light
- Divergence 4mrad FWHM
- 1.4km range @4km visibility
- Stable, given by white noise from Sun



Ronja + WiFi backup

- Reliability
- Throughput
- Special SW requirements
 - Immediate dropout detection



Mechanical mounting

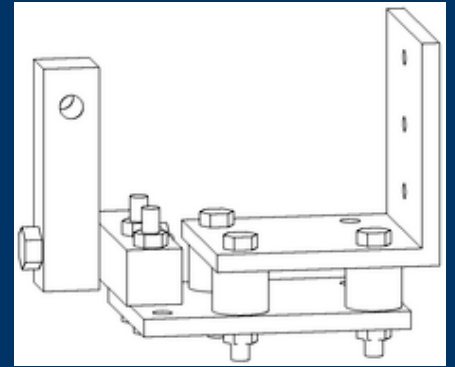

- Holder with fine and rough alignment
- 5 types of console
 - Chimney
 - Parallel
 - Perpendicular
 - Mast
 - Corner

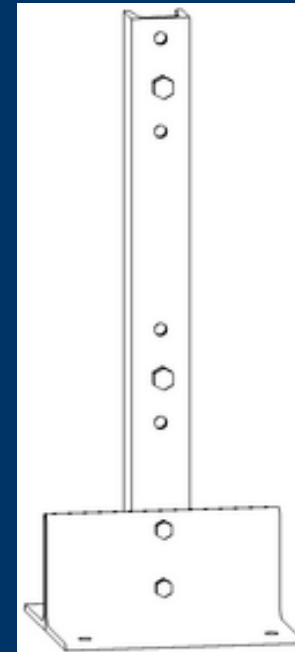
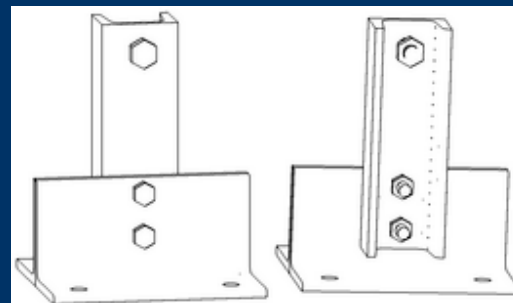
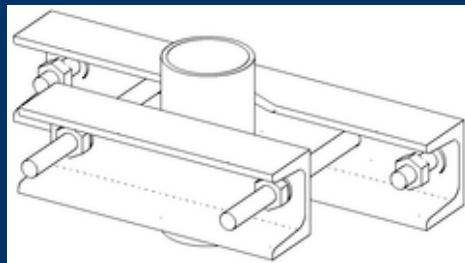
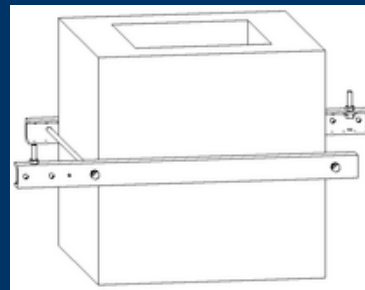

Manufacture

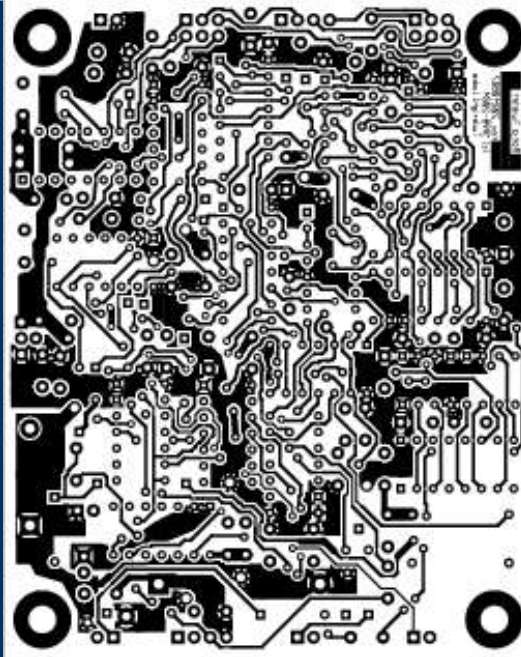

- DIY
- PCB in a factory
- Manual population
- Drilling, cutting, painting etc.
- Various operations can be ordered



Installations

- 96 registered installations
- 54 km total length
- 9 countries



Nearest Installation

Lausanne
300m, since 2003



Installations by country

96 total

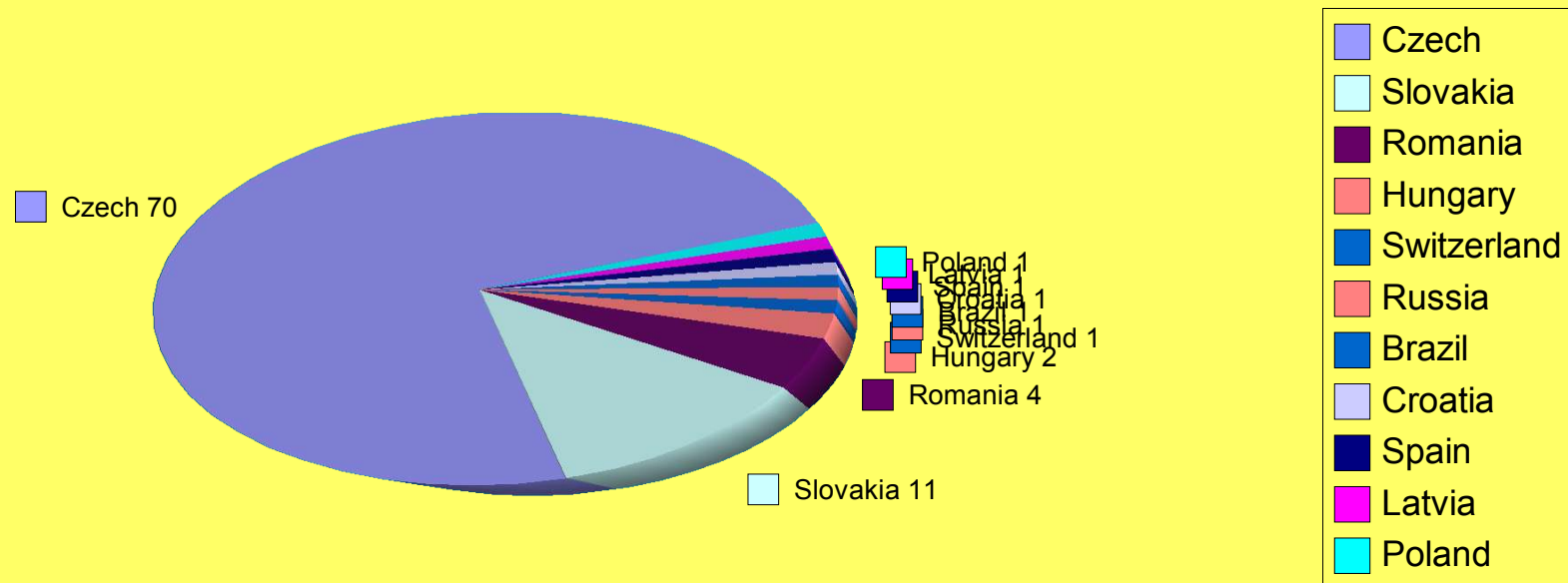

Top 4 cities

Cities with largest installation counts

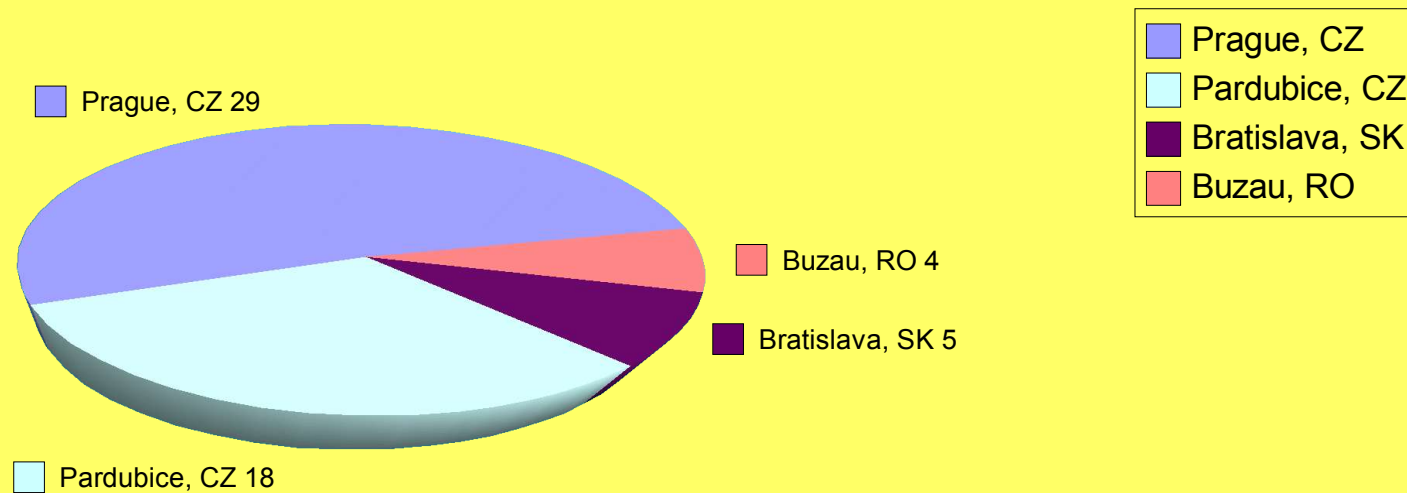

BRL-CAD

- Devel since 1979 by U. S. Army
- Since Dec 2004 continues as free SW



CSG modelling

- OR, AND, SUB on solid bodies
- Cylinder, box, sphere, torus, cone,...
- Weight etc. natively calculated

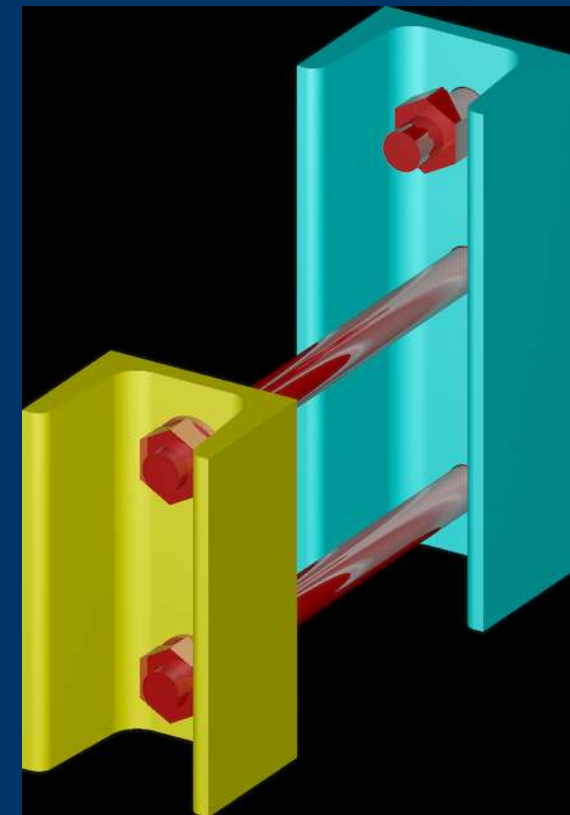
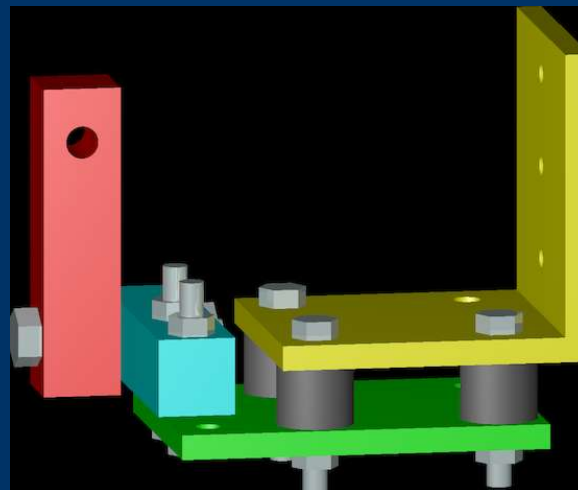
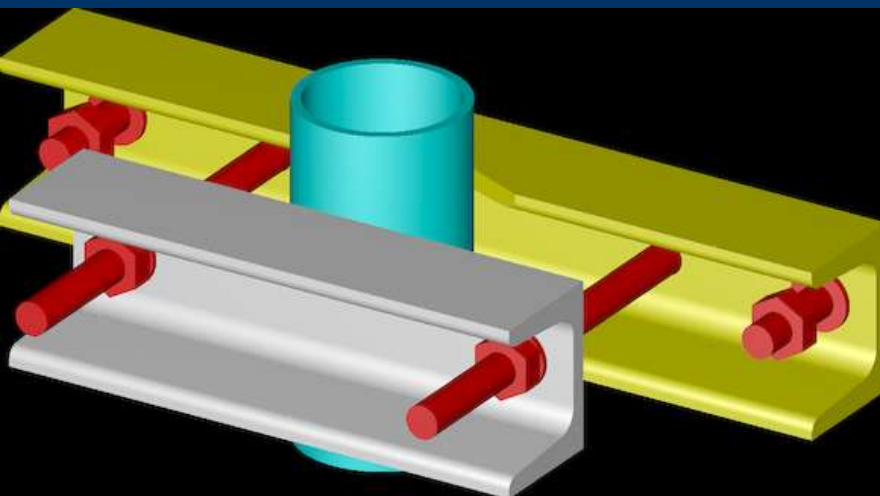

2D Drafting

- QCAD free SW
- Swiss
- DXF format
- Sketches: Sodipodi

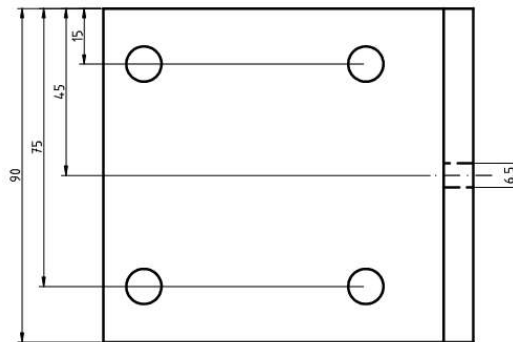
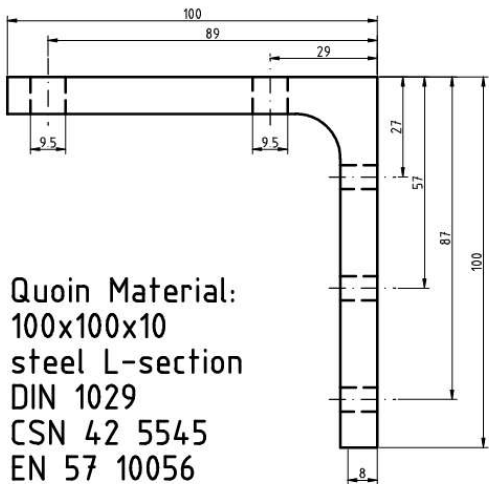

Quoin Material:
100x100x10
steel L-section
DIN 1029
CSN 42 5545
EN 57 10056

Schematics

- gEDA gschem
- Free SW
- ASCII file format
- Guile scripting

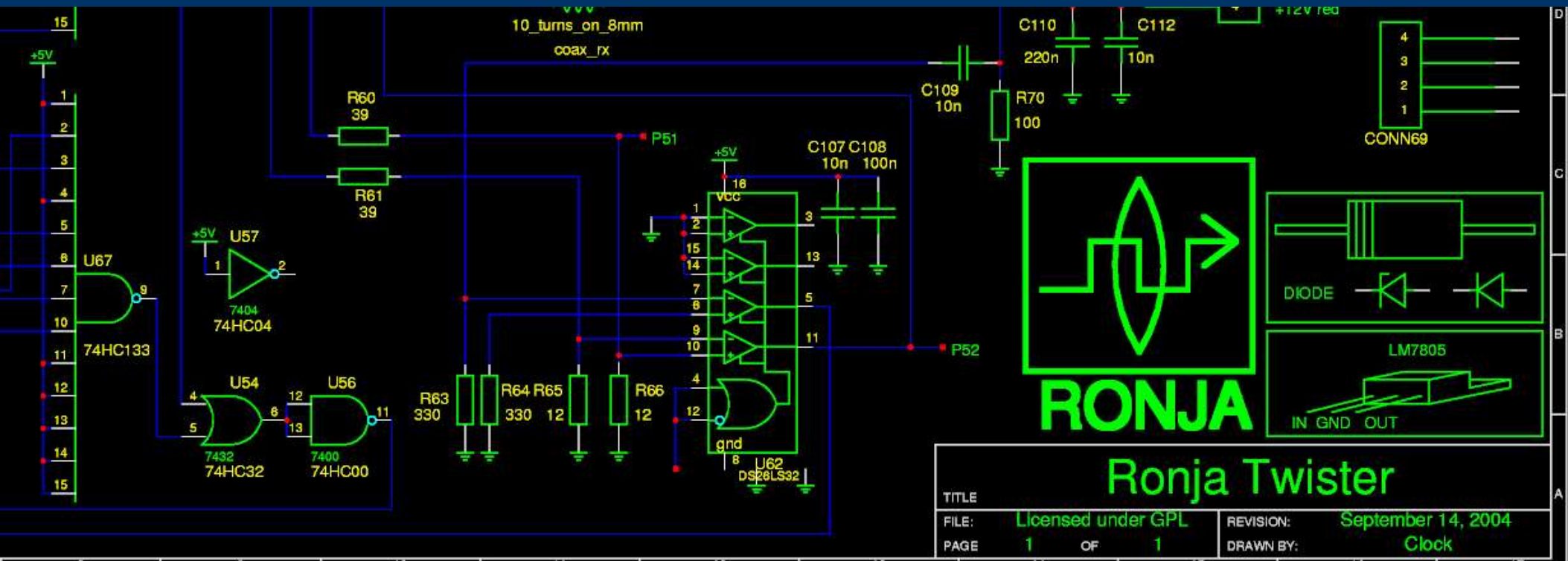
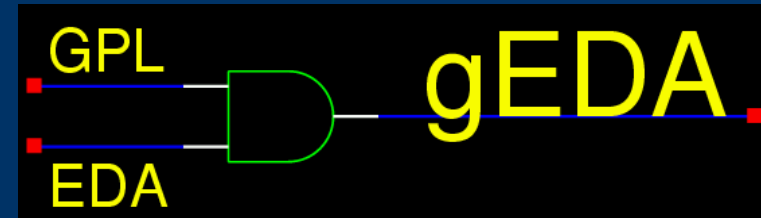

PCB design

- Free SW “PCB”
- ASCII file
- Up to 8 layers
- Soldermask
- Silkscreen
- Gerber RS274-X

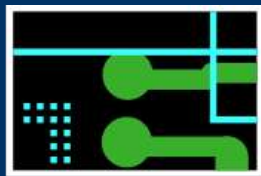

Gerbv

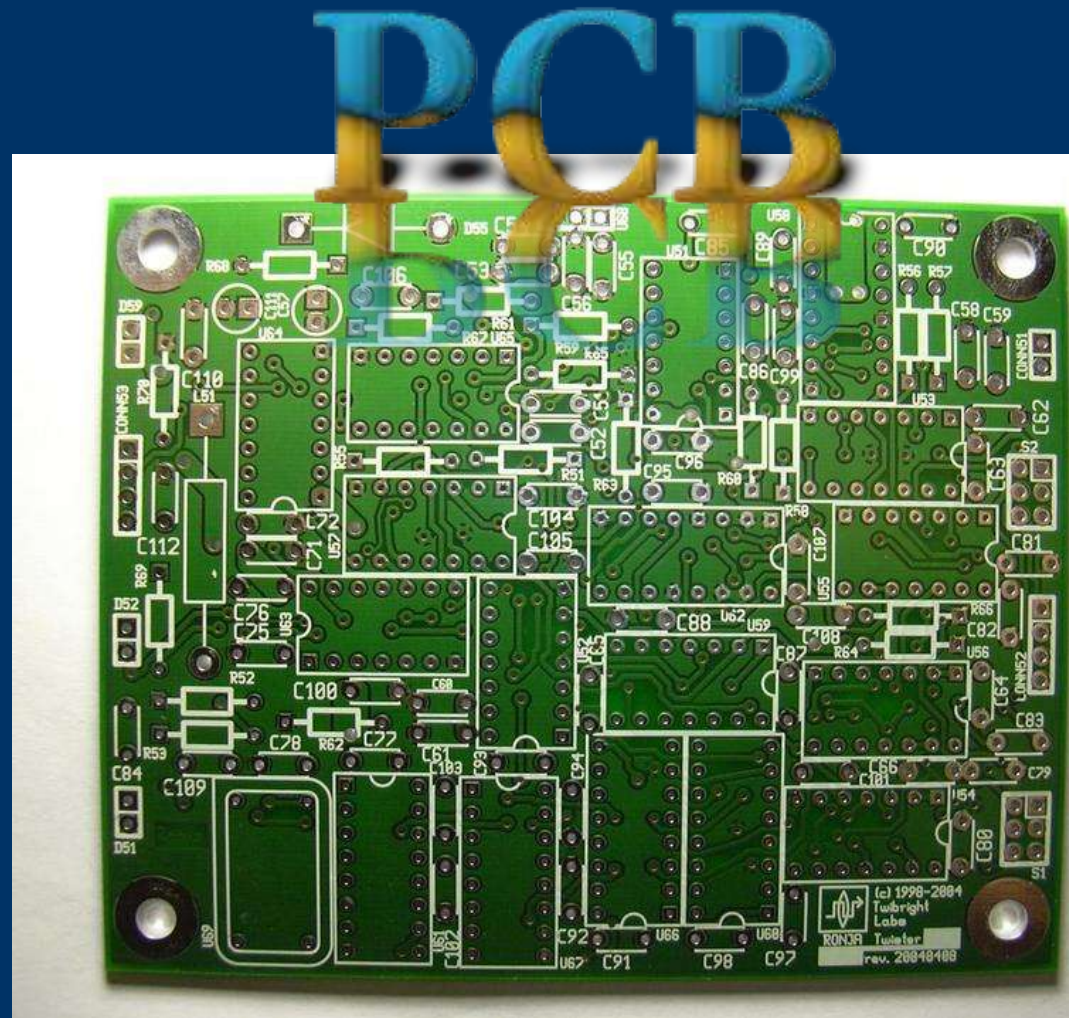

Scientific data visualisation

- Eye safety data
- Range & gain
- Oscilloscope waveforms
- Packetloss benchmarks
- gnuplot
- GNU R

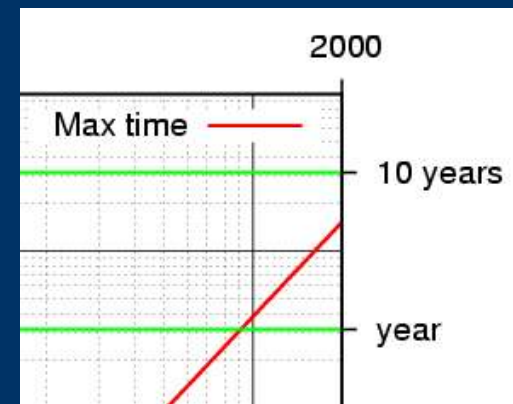

Web

- Apache
- PHP
- Rsync



Infrastructure

- GNU Make
- Perl scripts
- GNU Arch



A close-up photograph of a red fire extinguisher. The word "End" is written in a white, cursive, italicized font across the center of the extinguisher. The background is a dark blue gradient with a few horizontal orange lines at the bottom right.

End